

# QUINZEE CONSTRUCTION

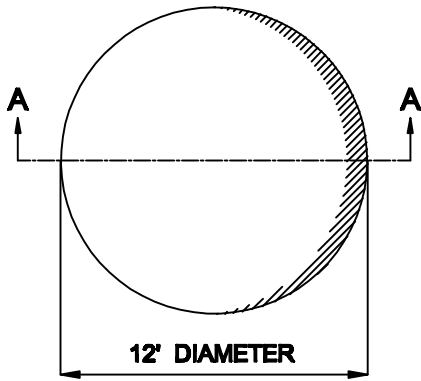

PLAN

## 1. LOCATION / LAYOUT

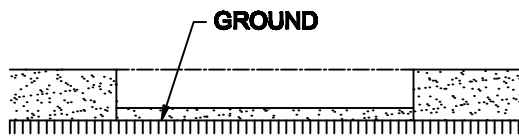

A-A

## 2. BREAK SNOW

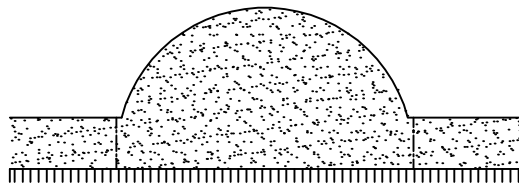

A-A

## 3. PILE SNOW

## (LUNCH BREAK)

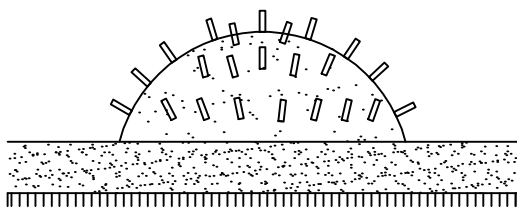

ELEVATION

## 4. INSERT STICKS

# QUINZEE CONSTRUCTION CONTINUED

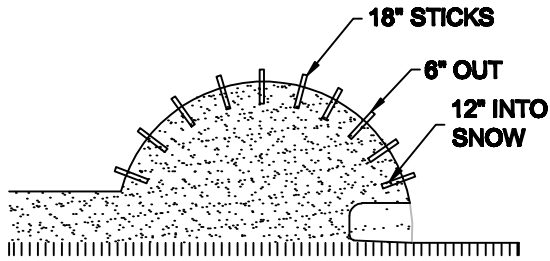

A-A

5. CUT ENTRANCE

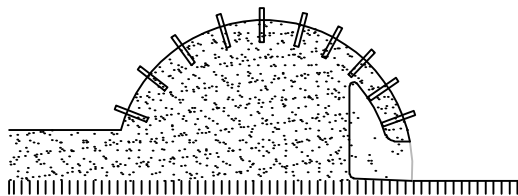

A-A

6. DIG UP!

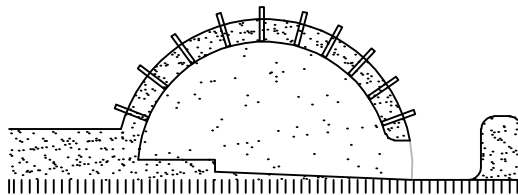

A-A

7. HOLLOW OUT

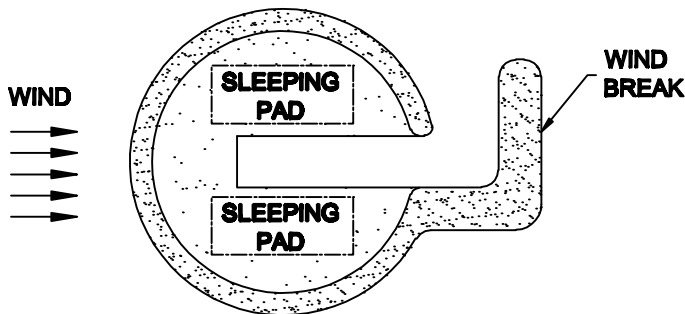

PLAN

8. MOVE IN